



**Polycom VVX 150 and VVX 250**  
Phone User guide

---

---

Overview of Phone Hardware and Keys .....	8
Navigating VVX Business Media Phones.....	11
<i>Accessing Screens on VVX Phone</i> .....	11
<i>Access the Home Screen</i> .....	11
<i>Access the Calls Screen</i> .....	12
<i>Access the Lines Screen</i> .....	12
<i>Access the Active Call Screen</i> .....	13
<i>Switch Among Phone Screens</i> .....	14
<i>Icons and Status Indicators</i> .....	14
Audio Calls .....	16
<i>Placing and Answering Audio Calls</i> .....	16
<i>Placing Audio Calls</i> .....	16
<i>Place a Call from the Dialler</i> .....	16
<i>Place an International Call</i> .....	16
<i>Place a Call from Recent Calls</i> .....	17
<i>Calling Favourites</i> .....	17
<i>Calling Contacts from the Directory</i> .....	17
<i>Call a Contact from a Directory</i> .....	17
<i>Call a Contact from the Directory Search Screen</i> .....	17
<i>Redial a Number</i> .....	18
<i>Answering Audio Calls</i> .....	18
<i>Answer an Incoming Call</i> .....	18
<i>Answer a Call from the Calls Screen if Voicemail Disabled</i> .....	19
<i>Answer a Call When in a Call</i> .....	19
<i>Switch Among the Handset, Headset, and Speakerphone</i> .....	19
<i>Mute and Unmute Audio</i> .....	19
<i>Holding and Resuming Calls</i> .....	19
<i>Hold a Call</i> .....	20
<i>Resume a Call</i> .....	20
<i>Ending Calls</i> .....	20
<i>End an Active Audio Call</i> .....	20
<i>End a Held Call</i> .....	20
<i>Transferring Calls</i> .....	20
<i>Choose a Default Transfer Type</i> .....	20
<i>Transfer a Call</i> .....	21
<i>Cancel a Transfer</i> .....	21

---

---

<i>Managing Calls</i> .....	21
<i>Display Calls from the Lines Screen</i> .....	22
<i>Display Calls from the Calls Screen</i> .....	22
<i>Manage a Call from the Calls Screen</i> .....	22
<i>Ignoring or Rejecting Incoming Calls</i> .....	22
<i>Ignore or Silence an Incoming Call</i> .....	23
<i>Reject Incoming Calls</i> .....	23
<i>Reject Calls from a Contact</i> .....	23
<i>Rejecting Calls with Do Not Disturb</i> .....	23
<i>Enable Do Not Disturb</i> .....	24
<i>Reject Calls with Do Not Disturb on Multiple Lines</i> .....	24
<i>Reject Calls with Do Not Disturb on One Line</i> .....	24
<i>Disable Do Not Disturb</i> .....	24
<i>Redirecting Incoming Calls</i> .....	25
<i>Forwarding Incoming Calls to a Contact</i> .....	25
<i>Forward an Incoming Call to a Contact</i> .....	25
<i>Forward All Incoming Calls to a Contact</i> .....	25
<i>Disable Call Forwarding</i> .....	26
<i>Divert Calls to a Contact</i> .....	26
<b>Conference Calls</b> .....	26
<i>Tips for Conference Calls</i> .....	26
<i>Audio Conference Calls</i> .....	26
<i>Initiate a Conference Call</i> .....	27
<i>Join Calls to Create a Conference Call</i> .....	27
<i>End a Conference Call</i> .....	27
<i>Hold a Conference Call</i> .....	28
<i>Resume a Conference Call</i> .....	28
<i>Split a Conference Call</i> .....	28
<b>Call Lists and Directories</b> .....	28
<i>Recent Calls</i> .....	28
<i>View Recent Calls</i> .....	28
<i>Sort Recent Call Entries</i> .....	28
<i>Sort Entries by Call Type</i> .....	29
<i>Edit a Recent Call Entry</i> .....	29
<i>Delete a Recent Call Entry</i> .....	29
<i>Save a Recent Call Entry</i> .....	29

---

---

<i>View Call Details</i> .....	29
<i>Contact Directory</i> .....	30
<b>Favourites</b> .....	31
<b>Phone Accessories and Computer Applications</b> .....	32
<i>Using a Headset with Your Phone</i> .....	32
<i>Connecting a Headset</i> .....	32
<i>Use Your Headset for All Calls</i> .....	32
<i>Reactivate Headset Memory Mode</i> .....	32
<i>Using Electronic Hookswitch</i> .....	32
<i>Setting the Headset Base Unit Options</i> .....	33
<i>Enable Electronic Hookswitch</i> .....	33
<i>Change the Headset Mode</i> .....	33
<i>Controlling Calls with Electronic Hookswitch</i> .....	34
<i>Disconnect Your Headset</i> .....	34
<b>Accessibility Features</b> .....	35
<i>Features for Hearing-Impaired Users</i> .....	35
<i>Accessibility Features for Hearing-Impaired Users</i> .....	35
<i>Features for Mobility-Impaired Users</i> .....	36
<i>Accessibility Features for Mobility-Impaired Users</i> .....	36
<i>Features for Vision-Impaired and Blind Users</i> .....	36
<i>Accessibility Features for Vision-Impaired and Blind Users</i> .....	37

---

---

## VVX 150 and VVX 250 Business IP Phones

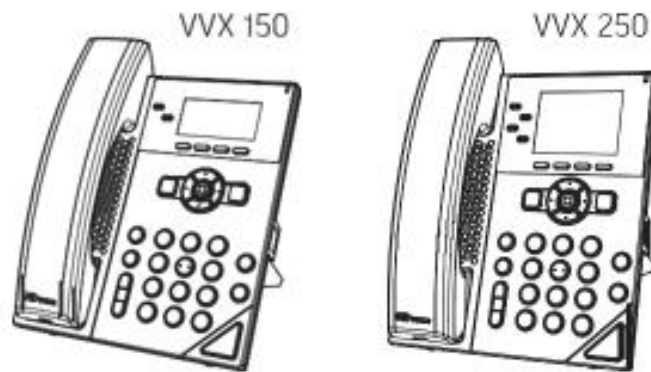

### Package Contents

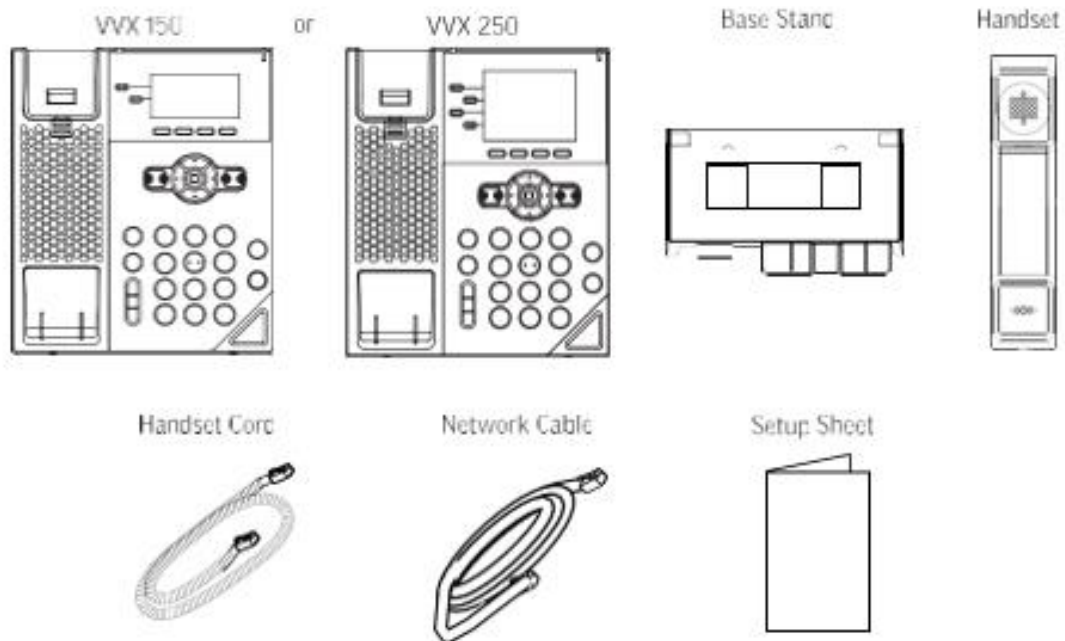

### Optional Accessories

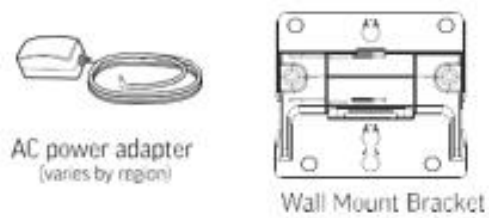

## Features

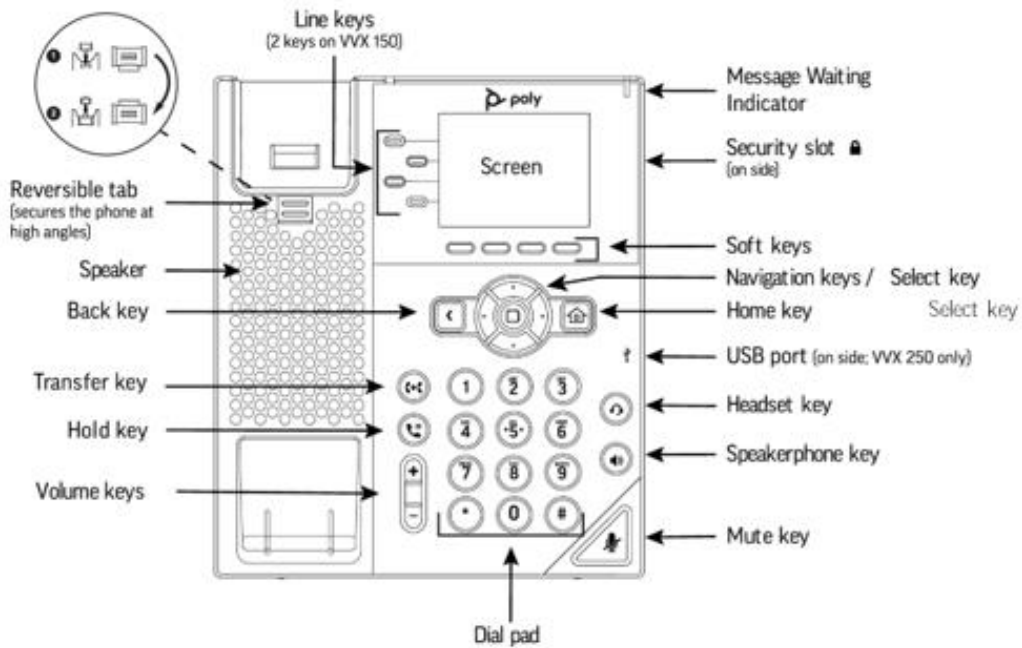

## Connect Cables

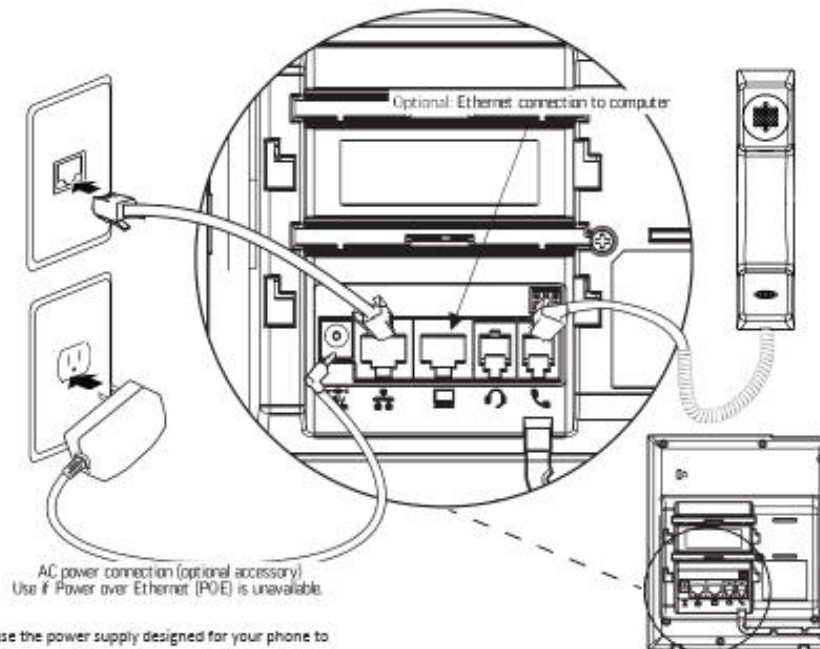

## Connect Stand

### Desktop

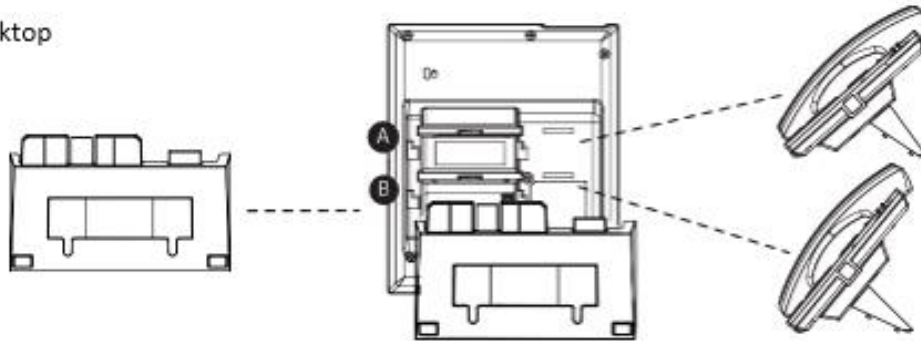

### Wallmount

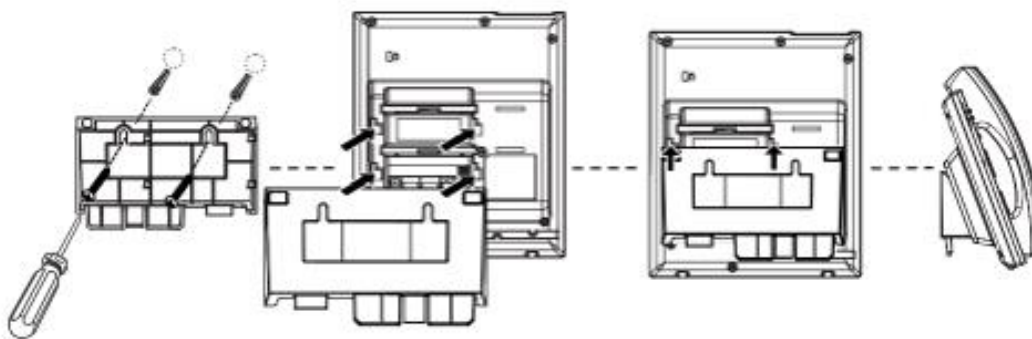

## Connect Optional Headset

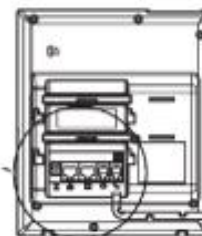
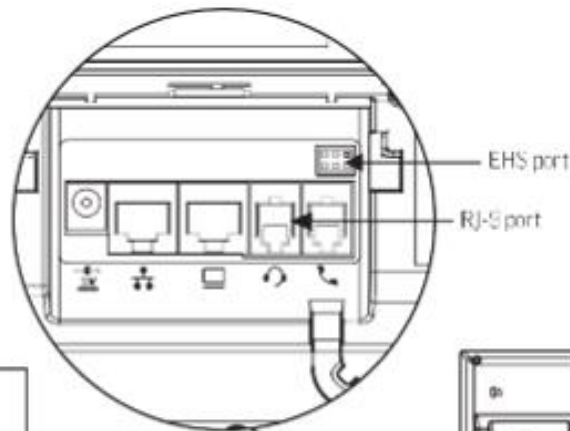

Note: Your phone supports USB and wired headsets, including Electronic Hookswitch (EHS) headsets.

For connection directions, refer to your headset documentation. Standard headsets typically use the RJ-9 or USB port while EHS headsets use the RJ-9 and EHS ports.

# Overview of Phone Hardware and Keys

Use the following figures and tables to understand your VVX phone's hardware features.

## VVX 150 series hardware features

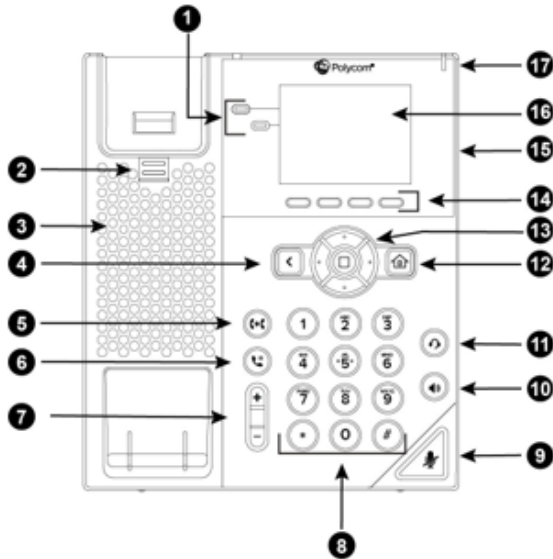

### VVX 150 Hardware Feature Descriptions

Reference Number	Feature	Feature Description
1	Line keys	Enable you to select a phone line, view calls on a line, or quickly call a favorite contact.
2	Reversible tab	Secures the handset in the cradle when your phone stand is positioned at a high angle. To secure the handset, remove the tab, reverse it so the protrusion points up, and re-insert it. Position the handset so the protrusion on the tab fits into the slot on the handset.
3	Speaker	Provides ringer and speakerphone audio output.
4	Back key	Enables you to return to the previous screen.
5	Transfer key	Transfers an active call to a contact.
6	Hold key	Holds an active call or resumes a held call.
7	Volume keys	Adjust the volume of the handset, headset, speaker, and ringer.
8	Dial pad	Enables you to enter numbers, letters, and special characters. You can also use the dial pad keys to select menu items that have index numbers.
9	Mute key	Mutes local audio during calls and conferences.



---

<b>Reference Number</b>	<b>Feature</b>	<b>Feature Description</b>
10	Speakerphone key	Enables you to place and receive calls using the speakerphone.
11	Headset key	Enables you to place and receive calls through a headset.
12	Home key	Displays the Home screen from other screens and displays the Lines and Calls screen from the Home screen.
13	Navigation keys / Select key	Scrolls through information or options displayed on the phone's screen. Selects a field of displayed data.
14	Soft keys	Enable you to select context sensitive keys that display along the bottom of the screen.
15	Security slot (on back)	Enables you to attach a universal security cable lock to your phone so you can secure it to a desktop.
16	Screen	Shows a 6.35 cm (2.5-inch) monochrome display that enables you to view menu options and data.
17	Message Waiting Indicator	Flashes red to indicate when you have new messages.

---

## VVX 250 series hardware features

Figure 2: VVX 250 hardware features

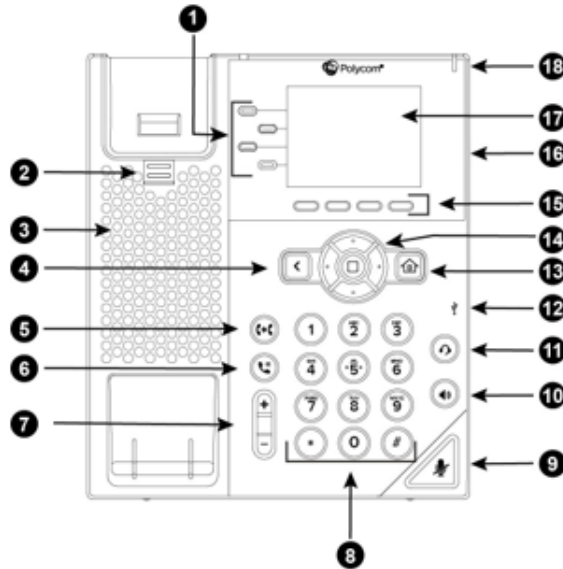

### VVX 250 Hardware Features

Reference Number	Feature	Feature Description
1	Line keys	Enable you to select a phone line, view calls on a line, or quickly call a favorite contact.
2	Reversible tab	Secures the handset in the cradle when your phone stand is positioned at a high angle. To secure the handset, remove the tab, reverse it so the protrusion points up, and re-insert it. Position the handset so the protrusion on the tab fits into the slot on the handset.
3	Speaker	Provides ringer and speakerphone audio output.
4	Back key	Enables you to return to the previous screen.
5	Transfer key	Transfers an active call to a contact.
6	Hold key	Holds an active call or resumes a held call.
7	Volume keys	Adjust the volume of the handset, headset, speaker, and ringer.
8	Dial pad	Enables you to enter numbers, letters, and special characters. You can also use the dial pad keys to select menu items that have index numbers.
9	Mute key	Mutes local audio during calls and conferences.

Reference Number	Feature	Feature Description
10	Speakerphone key	Enables you to place and receive calls using the speakerphone.
11	Headset key	Enables you to place and receive calls through a headset.
12	USB Port	Enables you to attach a USB flash drive or USB headset.
13	Home key	Displays the Home screen from other screens and displays the Lines and Calls screen from the Home screen.
14	Navigation keys / Select key	Scrolls through information or options displayed on the phone's screen. Selects a field of displayed data.
15	Soft keys	Enable you to select context sensitive keys that display along the bottom of the screen.
16	Security slot (on back)	Enables you to attach a universal security cable lock to your phone so you can secure it to a desktop.
17	Screen	Shows a 7.1 cm (2.8 in) color display that enables you to view menu options and data.
18	Message Waiting Indicator	Flashes red to indicate when you have new messages.

## Navigating VVX Business Media Phones

The phone has icons, status indicators, and user screens to help you navigate and understand important information on the state of your phone.

### Accessing Screens on VVX Phone

You can access the following screens on the phone:

- Home Screen—Displays your messages, settings, and information.
- Calls Screen—Displays all active and held calls on your line.
- Lines Screen—Displays your phone lines, favourites, and conditional soft keys.
- Active Call Screen—Displays the active call currently in progress.

### Access the Home Screen

On the VVX phone, the phone lines and icons you can select to access phone features, settings, and information display on the Home screen.

Home screen on VVX 150 phone

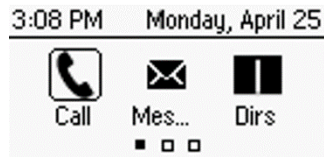

Home screen on VVX 250



1. Press .

### Access the Calls Screen

You can access the Calls screen when you have one held call or an active and held call in progress on your phone.

The Calls screen is automatically displayed when you have an active call and one or more held calls on your phone. The total number of calls is displayed on your line. If you have multiple lines on your phone, the calls display under the associated line, as shown next.

Calls screen on VVX 150 phone

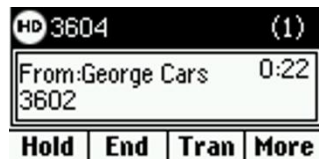

Calls Screen on VVX 250

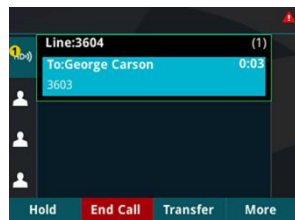

### Access the Lines Screen

The Lines screen is the default screen when your phone is not in use.

When you have multiple calls on your phone, the number of calls is displayed next to the line number. You can view your phone lines, and soft keys on the Lines screen, as shown next.

---

---

Lines screen on VVX 150

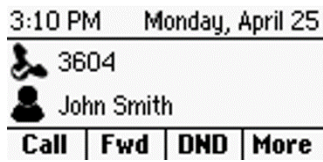

Lines screen on VVX 250

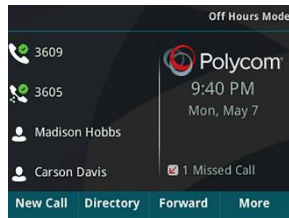

1. Do one of the following:
  - Press the Home key .
  - During a call, select the **Lines** soft key.

### Access the Active Call Screen

The screen is displayed when you place a call and when an active call is in progress. When an active call is in progress, the name and number of the contact you are talking with and the duration of the call is displayed. In the Active Call screen, you can hold, end, transfer a call, or set up a conference call.

Active Call screen on VVX 150 phone

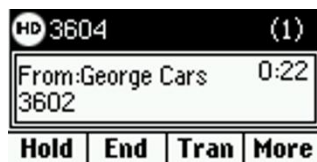

Active Call screen on VVX 250

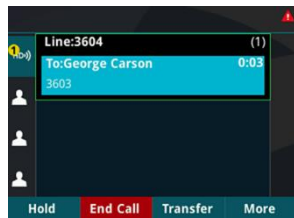

1. Do one of the following:
    - Place a call.
    - Press the Home key  during an active call.
-

---

## Switch Among Phone Screens



You can see any phone screen by pressing the Home key  or swiping your finger from right to left on the touchscreen. Although you can access any phone screen from whatever screen you are on, certain screens are only accessible if your phone is idle or has one or more calls in progress.

You can access these screens in the following scenarios:

- If your phone is not in use, you can access the Home and Lines screens.
- If your phone has an active call, you can access all screens.
- If your phone has one active call only, you can access the Home, Lines, and Active Call screens.
- If your phone has multiple calls, or one held call, you can access the Home, Lines, and Calls screens.
- If your phone is off-hook but not in a call, you can access Home and Lines screens.

### Procedure

1. Do one of the following:

- From the **Home** screen, press  to display either the Lines, Calls, or Active Call screen. The Calls and Active Call screen display only when an active or held call is in progress on your phone.
- Press the Home key  to display the Home screen from the Lines, Calls, or Active Call screen.
- When off-hook, press the **New Call** soft key to access the Lines screen.

























## Icons and Status Indicators

VVX phones have various icons and status indicators that display the status of the phone whether you are in a call or the phone is idle and not in use.

The following table displays the phone icons and status indicators that display on VVX phones.

---

## Icons and Status Indicators

Icon	Description	Icon	Description
	Registered line		Phone warning
	Unregistered line		Login credentials invalid
	Outgoing call		Shared line
	Active call using Polycom HD Voice		USB flash drive attached Not supported on VVX 150
	Held call		Call forwarding enabled
	Incoming call		Presence status (Available)
	Active conference		Presence status (Busy or In a Call)
	Do Not Disturb enabled		Presence status (Away)
	Favorite		Presence status (Do Not Disturb)
	Placed call		Presence status (Offline)
	Received call		Presence status (Offline)
	Missed call		New message
	Wireless network		

# Audio Calls

---

## Placing and Answering Audio Calls

VVX 150 phones can manage a maximum of 8 active, incoming, and held audio calls at a time. VVX 250 phones can manage a maximum of 24 active, incoming, and held audio calls at a time.

However, you can have only one active call in progress with numerous other incoming calls or calls on hold on all phones. Additionally, your system administrator can set up your phone to have up to six lines with unique extension numbers or the same extension number as other lines on your network.

## Placing Audio Calls

You can place calls on a VVX phone in numerous ways, including local and international calls, calls from Recent Calls or directories, calls to contacts or favourites.



## Place a Call from the Dialler

The Dialler enables you to enter a number to place a call and displays a list of previously placed calls. As you enter numbers, the Dialler displays a list of similar numbers in your directory. Select a match to automatically enter the number.

---

Note: Your system administrator can set up your phone to automatically place the call after you enter a certain number of digits. If a call is placed before you enter all the digits, add the number to your Contact Directory and dial the number from the Contact Information screen.

---

1. Do one of the following:
  - Start typing a phone number.
  - Select **New Call**.
  - Press a line key.
  - Pick up the handset, press  , or press .
2. Enter a number or select a recent contact.
3. Select **Dial**

## Place an International Call

You can place calls to international phone numbers on a VVX phone.

On the dialpad, quickly press the **star key** \* twice.

1. A plus sign + is displayed.



2. Enter the phone number with the country code and press **Dial**

### Place a Call from Recent Calls

You can place calls to contacts from the Recent Calls list, which contains calls that were recently placed, answered, or missed.

1. Do one of the following:
  - Navigate to **Directories > Recent Calls**.
2. From the **Calls List** screen, select a contact and select **Dial**.

### Calling Favourites

You can call your favourites from the Favourites list that you have added on the Business Portal.

### Calling Contacts from the Directory

You can search for and call contacts in your Contact Directory,

### Call a Contact from a Directory

You can place a call to a contact directly from your directory or you can select contacts in your directory to call from the New Call screen.

1. Do one of the following:
  - Select **Directories**.
  - Navigate to **New Call > Directory**.
2. Choose a directory.
3. From your directory, select or search for a contact.
4. Select the contact's phone number.
5. Select **Dial**.

### Call a Contact from the Directory Search Screen

You can search for and call contacts from the Search screen in your directory.

1. Navigate to **Directories** and select a directory.
2. Select Search, enter your contact's first or last name, and select **Search**.
3. Select your contact.
4. In the **Contact Information** screen, select the contact's number, and select **Dial**.

## Redial a Number

Your phone automatically keeps a record of all calls placed. You can recall the last contact you called using redial, if enabled by your system administrator

1. Do one of the following:
  - Select **Redial** on the Home screen.
  - Press the **Redial** soft key.

## Answering Audio Calls



When you receive an incoming call on a VVX business media phone, you can choose to answer the call in various ways, including answering calls automatically, in the Incoming Calls screen, in the Calls screen, and during a call.

## Answer an Incoming Call

When you receive an incoming call, the phone rings and an Incoming Call screen is displayed, as shown next. In the Incoming Call screen, you can choose to answer or reject the incoming call.

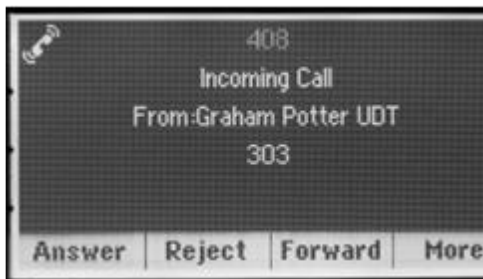
Incoming Call window



1. Do one of the following:
  - Pick up the handset.
  - Press  or select Answer.
  - Press .

After you answer the incoming call, the call becomes active.

### Answer a Call from the Calls Screen if Voicemail Disabled

When you don't answer an incoming call within 10 seconds, the Incoming Call screen disappears and the Calls screen is displayed.

1. Select the incoming call, and select Answer. **Note:** This will only work if Voicemail is disabled

### Answer a Call When in a Call

When you are in an active call and an incoming call arrives on the same or a different line, a call waiting tone beeps, and the Incoming Call screen is displayed.



If you don't answer the call within 10 seconds, the Incoming Call screen disappears, and the Calls screen is displayed.



1. Select Answer.



The active call is placed on hold, and the incoming call becomes active.

### Switch Among the Handset, Headset, and Speakerphone

You can place and answer calls on your phone using the handset, headset, or speakerphone, and you can alternate among the three modes during calls, if available.



When using the speakerphone, the Speakerphone key  glows green. When using the headset, the Headset key  glows green if an analogue headset is connected. Keys do not glow on VVX 150.

1. During a call, pick up the handset, press the Headset key  or press the Speakerphone key .

For example, if you're using the handset, press the Headset key  to switch to the headset, or press the Speakerphone key  to switch to the speakerphone.

### Mute and Unmute Audio

You can mute the microphone so other parties cannot hear you. Microphone Mute applies to the handset, headset, and speakerphone. You can still hear all other parties when you mute your microphone. When your audio is muted, the Mute icon is displayed and the Mute key glows red, excluding VVX 150 phones.

1. During a call, including a conference call, press . The other parties cannot hear you.
2. Press  again to unmute the microphone.

### Holding and Resuming Calls

When you are in a call, you can place an active audio call on hold and resume the call. You can place any active call on hold.

## Hold a Call

1. During an active call, select **Hold**.

If you're in the Calls screen, select the call first.

A hold icon  is displayed on the line of the held call, and a red LED light flashes on the line key, except VVX 150.

## Resume a Call

You can view and resume all held calls on the phone.

1. Do one of the following:
  - Select **Resume**.
  - From the Calls screen, select the call and select **Resume**.

## Ending Calls

You can end active calls at any time, however, you must resume held calls before you can end the call.

## End an Active Audio Call

You can end an active call on your phone at any time.

1. Do one of the following:
2. Place the handset on the cradle.
3. Press **End Call**.
4. In the Calls screen, highlight the call and press **End Call**.

## End a Held Call

You cannot end calls that are on hold. You must resume held calls before ending them.

1. From the Calls screen, select the held call and press **Resume > End Call**.

## Transferring Calls

You can transfer active or held calls to another person using the following transfer types:

- Blind transfer—Transfers the call directly to another line without speaking with the other party first.
- Consultative transfer—Enables you to speak with the other party before completing the transfer.

## Choose a Default Transfer Type

You can choose a default transfer type to use for all calls.

When you choose a default transfer type, the phone uses the selected transfer type for all calls. Consultative is the default transfer type.

1. Navigate to **Settings > Basic > Preferences**.
2. Select **Default Transfer Type** and choose a transfer type. The

selected transfer type is used for all calls.

### Transfer a Call

You can transfer a call to another contact and choose the transfer type you want to use for the call.

1. During a call, do one of the following
  - Press **Transfer** to use the default transfer type.
  - Press and hold **Transfer** to use the non-default transfer type.  
For example, if Blind is the default, press and hold Transfer to perform a Consultative transfer.
  - Press **Transfer > More**, and select **Blind** or **Consultative**.  
Depending on the default transfer type, either the Blind or Consultative option displays. For example, if the default transfer type is Blind, then you can select Consultative.
2. Dial a number or choose a contact from the Recent Calls or a directory. If the transfer type is set to Blind, the call is transferred immediately.
3. If the transfer type is set to Consultative, select Transfer after speaking with your contact.

### Cancel a Transfer

If a contact does not answer the transfer or you want to remain speaking with the contact on your line, you can cancel the transfer before it is complete.

1. Select **Cancel**.  
The call is not transferred and becomes active.

### Managing Calls

On VVX phones, you can see the number of calls on the line from the Lines screen, as shown next. A green light on the line key indicates a line with an active call, and a red light indicates a line with one or more held calls.

Multiple Calls on phone lines on the Lines screen

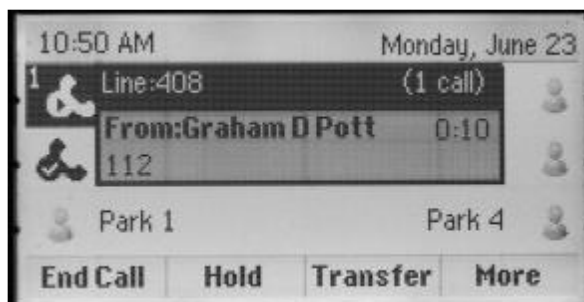

## Display Calls from the Lines Screen

You can display the calls for each line from the Lines screen.

When you select a phone line that has a held call, the first held call on that line is automatically resumed, even if you already have an active call on a different line.

- » » Press and hold the line key.

## Display Calls from the Calls Screen

You can view multiple calls on your line from the Calls screen.

- » Do one of the following:

- Press the Home key .
- From the Lines screen, press the **Calls** soft key.

The Calls screen is displayed with the list of active and held calls for each line on the phone.

## Manage a Call from the Calls Screen

From the Calls screen, you can manage a call by holding, resuming, or transferring the call.

1. Select a call.
2. Do one of the following:
  - Select **Hold** to place an active call on hold.
  - Select **Resume** to make a held call active.
  - Select **End Call** to end a call with a contact. You can end active calls only, so resume the held call first before ending it.
  - Select **Transfer** to send the call to another contact.
  - Select **Conference** to initiate a conference call.

## Ignoring or Rejecting Incoming Calls

When you receive an incoming call, you can choose to ignore or reject the call instead of answering. You can reject or ignore incoming calls, reject incoming calls from a specific contact, or enable Do Not Disturb to reject all calls for a brief time period.

---

Note: You cannot reject calls on shared lines. You can only silence the ringer.

---

## Ignore or Silence an Incoming Call

You can ignore or silence a call to stop your phone from ringing. Even if you ignore the call and silence the ringer, an incoming call notification continues to display on your phone.

1. From the Incoming Call screen, do one of the following:

- Select **Ignore** for private lines.
- Select **Silence** for shared lines.

The **Incoming Call** screen disappears, your phone stops ringing, and either the Home or Calls screen is displayed.

## Reject Incoming Calls

You can reject a call and send the call directly to voicemail. Rejected calls display in the Missed Calls list in your Recent Calls list. Rejecting calls is not available for shared lines.

1. From the **Incoming Call** screen, select **Reject**. The call goes directly to voicemail

## Reject Calls from a Contact



You can send incoming calls from a particular contact directly to your voicemail.

1. Navigate to **Directories > Contact Directory**.
2. From your **Contact Directory**, select a contact.
3. From the **Contact Information** screen, select **Edit**
4. From the **Edit Contact** screen, select **Auto Reject > Enabled** and select **Save**. Calls from the contact are sent directly to voicemail when the contact calls.

## Rejecting Calls with Do Not Disturb

Do Not Disturb (DND) enables you to set your phone to automatically reject calls when you do not want to be interrupted.

When you enable Do Not Disturb (DND), the following occurs:

- The DND icon  displays in the status bar.
- When the phone is idle, the DND icon is displayed next to your phone line on the Lines screen.
- If you have new messages or call forwarding is enabled, the messages or forwarding icon is displayed instead of the DND icon.
- The message “Do Not Disturb” is displayed in the status bar on all phones.
- For VVX 150 phones, the line icon changes to .

---

Note: When you set your presence status to Do Not Disturb, as well as enable DND for your phone, a message stating that your status is set to Do Not Disturb scrolls under the time display, and the DND icon does not display in the status bar.

## Enable Do Not Disturb

You can enable DND to prevent your phone from ringing and to send all incoming calls directly to voicemail. All calls you receive while DND is enabled are logged in the Recent Calls list.

Enabling DND on shared lines disables ringing only. A visual notification of the call still displays, and you have the option to answer or ignore the call.

---

Note: When you are signed into a host phone as a guest, you can only enable Do Not Disturb if the server-based Do Not Disturb feature is enabled on the phone. If server-based DND is disabled on the phone, you cannot use DND on the host phone. Contact your system administrator for help enabling this feature.

---

1. Select **DND**.

## Reject Calls with Do Not Disturb on Multiple Lines

By default, the Do Not Disturb feature applies to all lines on your phone. Your system administrator can set up your phone so that you can enable the feature on a per-line basis.

1. Select **DND**.
2. Select **Set All** to enable DND for all lines.

## Reject Calls with Do Not Disturb on One Line

If you have more than one line, you can choose to enable DND for a particular line and not all lines, if enabled.

1. Select **DND**.
2. From the **Line Select** screen, select a line.
3. From the **Do Not Disturb** screen, select **Enable**.

## Disable Do Not Disturb

You can disable DND when you are ready to resume receiving calls again.

Procedure

1. Select **DND**.



## Redirecting Incoming Calls

You can redirect incoming calls by forwarding an incoming call to a contact, forwarding all incoming calls to a contact, or diverting calls from a specific contact to another contact.

## Forwarding Incoming Calls to a Contact

You can choose to forward an incoming call to a contact or forward all incoming calls to one of your contacts.

---

**Note:** When you are signed into a host phone as a guest, you can only forward calls if the server-based Call Forwarding feature is enabled. If server-based Call Forwarding is disabled, you cannot forward calls to a contact from the host phone. Contact your system administrator for help enabling this feature.

---

## Forward an Incoming Call to a Contact

You can forward an incoming call directly to a contact without answering the call. You cannot forward calls in this way on shared lines.

### Procedure

1. In the **Incoming Call** screen, select **Forward**.
2. From the **Call Forwarding** screen, enter the forwarding number, and select **Forward**.



## Forward All Incoming Calls to a Contact

You can set up your phone to forward all incoming calls to a contact using one of the following forwarding types:

- **Always**—Forwards all incoming calls.
- **No Answer**—Forwards all unanswered incoming calls.
- **Busy**—Forwards incoming calls when you're in a call.

For shared lines, you can only choose Always as your forwarding type; the other forwarding options are not available for shared lines.

### Procedure

1. Select **Forward** or navigate to **Settings > Features > Forward**.
2. If your phone has multiple lines, select a line.
3. On the **Forwarding Type Select** screen, select a forwarding type.
4. Enter a contact's number or IP address, if enabled, and select **Enable**.
5. If you selected the **No Answer** option, enter the number of rings before the call is forwarded.  
 The forwarding number or name of the contact you chose scrolls in the status bar. When you select **Always** as your forwarding option, the Forwarding icon  is displayed on the line.

## Disable Call Forwarding

You can disable call forwarding when you no longer want to forward your calls.

### Procedure

1. Select **Forward**.
2. If your phone has multiple lines, select a line.
3. From the **Forwarding Type Select** screen, select your forwarding type, and select **Disable**.

## Divert Calls to a Contact

You can divert all incoming calls from a particular contact to another contact.

### Procedure

1. Select **Directories > Contact Directory**.
2. From the **Contact Directory**, select a contact.
3. From the **Contact Information** screen, select **Edit**.
4. From the **Edit Contact** screen, select **Divert Contact**, and enter a contact's number.
5. Select **Auto Divert > Enabled**.
6. Select **Save**.

# Conference Calls

---

You can initiate audio conference calls with various contacts on your VVX phone. When you initiate a conference call, you can hear audio for two or more contacts, manage conference participants, and join calls into a conference or split a conference into individual calls.

## Tips for Conference Calls

When you are in a conference call, follow these tips:

- Use the handset or a headset if you're in an open environment.
- Mute your microphone when you are not speaking, especially in noisy environments.
- Avoid tapping or rustling papers near the microphone.
- Speak in your normal voice without shouting.

## Audio Conference Calls

You can initiate an audio conference call with two contacts and hold, resume, or split a conference call on your VVX phone.

You can initiate an audio conference call with two contacts and hold, resume, or split a conference call on VVX business IP phones.

VVX 150 phones can manage a maximum of 4 active or held conference calls at a time. VVX 250 phones can manage a maximum of 12 active or held conference calls at a time. However, you can have only one active conference call in progress with numerous other conference calls on hold.

If your system administrator enables the Conference Management feature on your phone, you can manage each participant in the call. With the Conference Management feature, you can mute, hold, and remove individual participants in a conference call.

### Initiate a Conference Call

You can initiate a conference by calling two people and selecting the Conference soft key or hard key.

---

Note: When your phone is set up for single key press conferences, you do not need to tap the Conference soft key or press the Conference key a second time to join parties to a conference call.

---

1. Call a contact.
2. After the contact answers, select the **Conference** soft key. The call is held.
3. Enter another contact's number or select a contact from the directory or the call lists.
4. When the contact answers, select the **Conference** soft key.  
All call participants are added to a conference call.

### Join Calls to Create a Conference Call

You can join one active call and one held call into a conference call. If you have more than one call on hold, you can select a held call to join into a conference call with the active call.

1. Do one of the following:
  - When you have an active call and a held call, select the **Join** soft key.
  - When you have an active call and more than one held call, select a held call and then select the **Join** soft key.

The active call and the selected held call are joined into a conference. If you have multiple held calls, the other held calls on the line remain held.

### End a Conference Call

By default, when you end a conference call, your connection to the call ends and the other participants in the conference remain in the call.

However, your system administrator can set up your phone so that all connections terminate when you end a conference call.

1. During a conference call, select **End Call**.

## Hold a Conference Call

When you place a conference call on hold, you place all conference participants on hold.

1. Select **Hold**.

## Resume a Conference Call

Resuming a held conference call enables all participants to hear the audio of everyone on the call.

1. Select **Resume**.

## Split a Conference Call

When you split a conference, you end the conference call and place the other two people on hold. You can split an active or held conference call. After you split a conference call, you can resume one of the held calls.

1. During a conference call, select the **Split** soft key.

The conference call ends and the two participants are held in two separate calls.

# Call Lists and Directories

---

## Recent Calls

The Recent Calls list on VVX phones includes missed, received, and placed calls. Each list holds up to 100 entries.

You can perform the following tasks from the Recent Calls list:

- Sort, order, and filter calls. By default, the list displays all call types with the most recent call displaying first.
- Remove calls from the list.
- Select a call record to view call details.
- Select a call record to automatically call a contact.

## View Recent Calls

In the Recent Calls list, you can view a list of up to 100 missed, received, and placed call entries.

1. Do one of the following:
  - Navigate to **Directories > Recent Calls**.

## Sort Recent Call Entries

You can customize the Recent Calls list to view calls by call type, time, and call name.

When you sort calls by the time of the call, you can order them in ascending (oldest call first) or descending (most recent call first) order. When you sort calls by name, you can order them in ascending (alphabetical) or descending (reverse-alphabetical) order

1. Select **Sort**
2. Under **Sort**, choose **Time** or **Name**.
3. Under **Order**, choose **Ascending** or **Descending**.

### Sort Entries by Call Type

When you filter calls, you can choose to display only missed, received, or placed calls. You can also choose to display all call types (the default).

---

Note: You cannot save your filtered call list results. If you filter your Recent Calls list so that only a certain call type displays, the next time you display the list, all call types display in the default filter.

---

1. Select **Type**
2. Choose **Missed Calls**, **Received Calls**, or **Placed Calls**.

### Edit a Recent Call Entry

You can edit a contact's phone number stored in your Recent Calls list before returning the contact's call.

1. Select **Info**
2. Select **Edit**
3. Edit the number and select **Dial**

### Delete a Recent Call Entry

You can delete any recent call entry from the Recent Calls list.

1. Select **Info**
2. Select **Delete**

### Save a Recent Call Entry

You can save a recent call entry to the Contact Directory.

1. Select **Info**
2. From the **Call Details** screen, select **Save**.

If the person is already in your Contact Directory but is not a favorite, **Add to Favorites** is displayed.

### View Call Details

In the Recent Calls list, you can view call details, edit call details before calling a contact, save a contact to your directory, and delete call entries.

**1. Select Info**

**Contact Directory**

All contacts should be managed via the Business Portal and not via the phone

## Favourites

---

This cannot be managed by the phone and should be configured via the Visual Device Manager

# Phone Accessories and Computer Applications

---

## Using a Headset with Your Phone

You can connect a headset to your VVX phone and use the headset to place and answer calls, handle all calls using a headset, and use electronic hookswitch (EHS).

You can connect an analog headset to all VVX phones.

---

**Note:** For information on your headset's features, as well as how to sync your headset with your phone, see your headset's documentation.

---

## Connecting a Headset

Your phone does the following when connected to analogue headsets:

- Note that the headset key does not glow on VVX phones.

After you connect a headset to your phone, you can set up your phone to use the headset automatically when answering and placing calls.

## Use Your Headset for All Calls

You can set up your phone so that all incoming and outgoing calls automatically use your headset. To use this feature, you must enable and activate Headset Memory Mode

1. Navigate to **Settings > Basic > Preferences > Headset > Headset Memory**.
2. From the **Headset Memory Mode** screen, select **Enabled**.
3. Press the headset key twice.

The headset key flashes to indicate that Headset Memory Mode is now activated. All calls placed or answered on your phone use your headset automatically.

---

**Note:** If you or your contacts experience audio or echo issues during calls, such as feedback of your voice or of their own voice, you need to enable echo cancellation on your phone.

---

## Reactivate Headset Memory Mode

Switching to the speakerphone or the handset deactivates Headset Memory Mode

1. Press the headset key twice.

## Using Electronic Hookswitch



When you use a headset that supports electronic hookswitch (EHS), you can place, answer, and end calls by using the controls on your headset. To use EHS, you need a headset that includes a serial control interface in addition to the standard analog headset jack (RJ-9) interface. The serial control interface requires an EHS adapter that you can purchase from your headset manufacturer.

Headsets that support EHS include a base unit that connects to your phone. The headset connects to the base unit wirelessly, which enables you to use your headset even if you're some distance away from your phone. Typically, you can work wirelessly up to 300 feet (91 meters) from your phone and still use the EHS controls. Check with your headset's user guide for the precise range restrictions.

### Setting the Headset Base Unit Options

Before you connect your headset to your phone and use EHS, you need to set the following options for your specific headset model:

- For Jabra headsets, change the headset mode to **DHSG** on the headset base unit. For details, refer to your headset documentation or contact Jabra support.
- For Plantronics headsets, change the coarse receive level to 3 and the transmit level to B on the headset base unit. For details, refer to the guide that comes with your headset.
- For Sennheiser headsets, set the first DIP switch labeled 1 (DHSG) to the down position on the back of the headset base unit. For additional details, see your headset's documentation or contact Sennheiser support.

### Enable Electronic Hookswitch

After you set the base unit options for your headset and connect your headset to your phone, you can enable EHS.

1. Connect your headset and EHS adapter to your phone.  
See the Quick Start Guide for your phone on Polycom Voice Support for information on connecting a headset to your phone.
2. Navigate to Settings > Basic > Preferences > Headset > Hookswitch Mode.
3. Select one of the below modes for your specific headset:
  - Choose **Jabra** if an EHS-compatible Jabra headset is attached with an EHS cable or adapter.
  - Choose **Plantronics** if an EHS-compatible Plantronics headset is attached with an EHS cable or adapter.
  - Choose **Sennheiser** if an EHS-compatible Sennheiser headset is attached with an EHS cable or adapter. If your phone does not have a menu selection for Sennheiser, select Jabra instead.
  - Choose **Regular Mode** (default) if another headset is attached.

### Change the Headset Mode

Headsets that come with a docking station have two modes: soft phone and desk phone mode. To control your phone using your headset, the headset must be in soft phone mode. If you cannot operate the phone from your headset, it is possible your headset is in desk phone mode

1. Press and hold the headset hookswitch until you hear a sound or message on the headset.

### **Controlling Calls with Electronic Hookswitch**

After you have followed the procedures for connecting your headset and enabled EHS, you can use the controls on your headset to answer, mute, and end calls. If supported on your headset, you can also place calls on hold. See your headset's user documentation for information on controlling calls from your headset.

When you are in an active call and you receive an incoming call, you cannot use the hookswitch control on your headset to place the active call on hold and answer the incoming call. Pressing the hookswitch control on the headset ends the active call and answers the incoming call. To place the existing call on hold and answer the incoming call, answer the call on your phone.

### **Disconnect Your Headset**

If you want to disconnect or change your headset, you need to properly detach your headset from your phone.

- 1.** Navigate to **Settings > Basic > Preferences > Headset > Hookswitch Mode**.
- 2.** Select **Regular Mode**.
- 3.** Remove the EHS adapter from the serial port on the back of the phone.

# Accessibility Features

---

Polycom products include a number of features to accommodate any type of user. The following sections describe accessibility features for hearing, vision, or mobility-impaired users available on VVX Business Media Phones.

## Features for Hearing-Impaired Users

Polycom phones include many features that enable users with hearing impairments to use various features on the phone.

The following table lists the accessibility features for hearing-impaired users.

### Accessibility Features for Hearing-Impaired Users

Accessibility Feature	Description
Visual message indicators	An indicator light on the phone indicates that new messages are waiting. Icons on the screen also indicate that the phone has new messages.
Adjustable ring tone and volume	You can choose from a variety of ring tones for the phone. You can also change the volume of the ringer to suit your needs and choose different ring tones for contacts.
Adjustable Call Volume	While in a call, you can raise or lower the volume of the audio from the far end and of any other sounds on the device.
Visual notifications	Status and icon indicators let you know when calls are incoming, outgoing, active, or held. Indicators can also indicate the device's status and if features are enabled.
Visual ringing	Certain VVX models have visual ringing that enables the screen to flash bright orange for incoming calls (contact your system administrator to enable this feature).
Electronic hookswitch	If you use a headset that supports electronic hookswitch (EHS), you can use the controls on your headset to answer and end calls. Additionally, you may be able to mute calls and control volume from your headset.

Accessibility Feature	Description
Headset Memory Mode	If you use a headset, you can set up your phone to use your headset for all calls.

Hearing Aid Compatible (HAC) handsets	All phones are Hearing Aid Compatible (HAC) and have telecoils that magnetically couple to most forms of wearable hearing aids per FCC section 508 (compliant to ADA Section 508 Recommendations: Subpart B 1194.23).
TTY support	The phones supports commercial TTY devices such as Ultratec Superprint. Additionally, the phones provide acoustic coupled TTY support.

### Features for Mobility-Impaired Users

Polycom phones include features that enable users with mobility impairments to perform various functions on the phone.

The following table lists the accessibility features for mobility-impaired users.

#### Accessibility Features for Mobility-Impaired Users

Accessibility Feature	Description
Auto-answer feature	You can enable the phone to auto-answer calls so you don't have to choose an option to answer a call.
Headset Memory Mode	If you use a headset, you can set up your phone to use your headset for all calls.
Large keys	The large keys on the phone console enable you to access phone features and functions.
Built-in speakerphone	A built-in speakerphone allows you to hear audio on the device without having to use a handset or headset.
Adjustable phone stand	You can adjust the phone stand to various angles so your phone sits at a comfortable angle on your desktop.
Polycom Desktop Connector	You can use your computer's mouse and keyboard to enter information and navigate screens on your phone.

### Features for Vision-Impaired and Blind Users

Polycom phones include various features that enable users with visual impairments to use many of the features on the phone.

The following table lists the accessibility features for visually-impaired and blind users.

## Accessibility Features for Vision-Impaired and Blind Users

Accessibility Feature	Description
Adjustable backlight settings	You can change the brightness of the screen by adjusting backlight intensity settings.
Auto-answer feature	You can enable the phone to auto-answer calls so you don't have to choose an option to answer a call.
Tactile "5" key with raised bumps	The "5" key has two bumps that enable you discern the position of other keys on the keypad.
Large keys	The large keys on the phone console enable you to access phone features and functions.
Physical line keys	VVX 300 series and 400 series phones have physical line keys that you can press to answer and end calls.
Physical feature keys	Many features on the phones are accessible by pressing feature keys on the phone console.
Tactile-discernible number, feature, and navigation keys	Keys on the phone console are discernible by their size and shape.
Illuminated feature keys	Many feature keys are illuminated when activated so you're alerted when a feature is enabled.
Microphone mute feature	The system plays an alert tone when the microphones are muted or unmuted using any of the Mute keys on the device or far-end system. The system plays an alert tone periodically if the device is muted for a set period of time.



Phone: 0330 124 1818

E-mail: [sales@thevoipshop.co.uk](mailto:sales@thevoipshop.co.uk)

Dock, Pioneer Park, Office 101, 75 Exploration Drive, Leicester, LE4 5NU

COMPANY REGISTRATION NUMBER: 05693707

[www.thevoipshop.co.uk](http://www.thevoipshop.co.uk)